

AA171408F-ABF12-BCD-220V

H₂O-To-Go! Bottle Filler And Water Cooler Combo



Specification

Manufactured from #304 stainless steel with exposed surfaces in satin finish. Water-efficient, anti-microbial flexible bubbler with self-closing button. Sensor activated bottle filler includes easy to read digital bottle counter display to highlight water savings. Push-button bottle filler model available upon request. Includes AA171408F-UG-220V and ABF12-BCD-IPL.

Inlet Connection:	1/2" BSP
Outlet Connection:	40mm BSP
Water Pressure:	200-500 kPa
Basin & Housing:	1.6mm, Type 304 Stainless Steel
Refrigerant:	R-134a
Power Requirement:	220VAC 50Hz, Single Phase
Capacity:	30L/hr Drinking Water At 10°C (Incoming 27°C, Ambient 32°C)

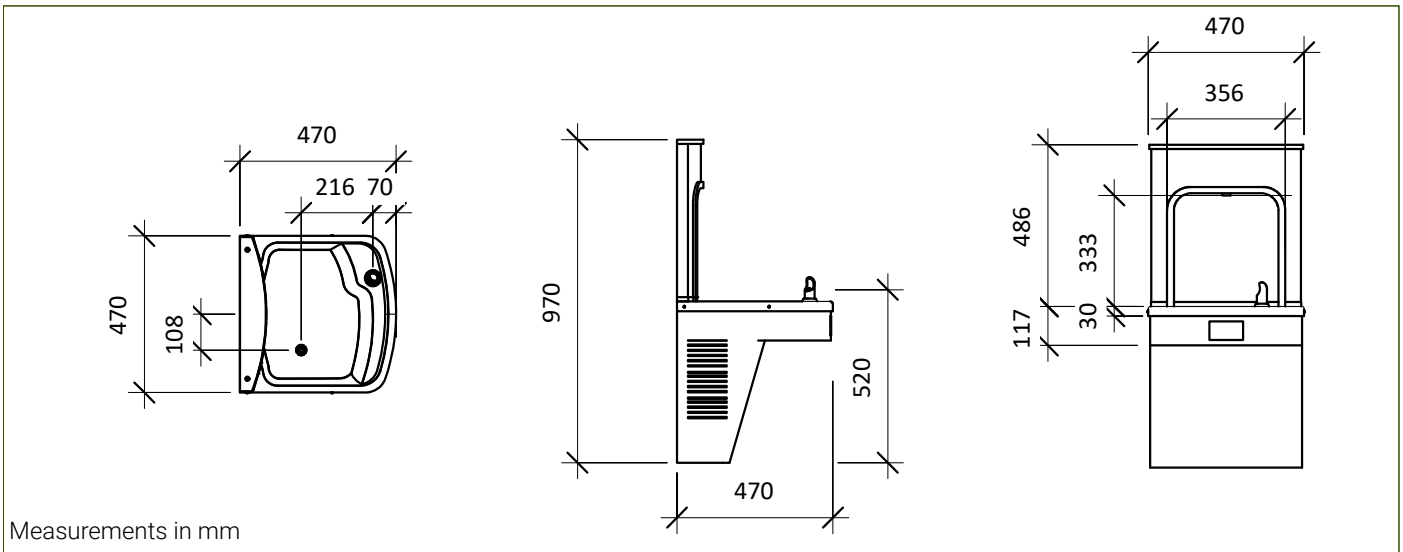

Resources

[Installation Guide](#) - [Warranty & Cleaning Guide](#) - [CAD Drawing](#)

As improvements in the design and performance of Bubblers Australia products are continuous, specifications may be subject to change without notice. The illustrations and descriptions herein are applicable to production as of the date of this Technical Data Sheet. Revised 04/25 © 2025 by Bubblers Australia TD/ModelAA171408F-ABF12-BCD-220V/0425